



Passive Cooling Systems

Air Conditioning Without the Need of Energy

1 Introduction and Abstract



PCS Shelter for ADCO SAS project in the UAE/Sahil and Shah

Pipe Lines and Supply Networks often run through remote areas, like deserts, in which no safe power supply is always available. Measuring and supervision might be necessary in these areas too. SCADA systems have usually only small energy consumption and can be powered by solar cells with back-up batteries. The maximum temperatures in the shade can be as high as 58°C and the solar radiation adds additional heat. Without any cooling the temperatures in shelters and housings may exceed 80°C. In these conditions electronic equipment will not function reliably any longer.

Active air conditioning systems, such as compressor and absorber air conditioners, require too much energy to function with solar cells. The solution is passive cooling.

How does that function? Passive Cooling Systems use the high temperature differences (ΔT) between day and night, which arise in arid desert regions. The thermal capacity of heat distribution medium, e.g. water, stores the coolness of the night to keep the interior at a moderate temperature during the day.

A Passive Cooled Shelter is an integral system consisting of housings with insulation, sun shade, external and internal heat exchangers, heat storage and conveyance of the medium, which must be designed for the specific application.

INTERTEC engineered, built and supplied a number of passively cooled cabinets and shelters for projects of customers such as Saudi Aramco, ADCO, TR, Siemens, ABB or Cegelec with the self developed dynamic simulation tool INTERSIM.



2 Function principle

Passive cooling systems function by a large heat storage. Water, having a large thermal capacity, is a very good medium for storing and distributing the coolness of the night.

Passive Cooling System: Principle

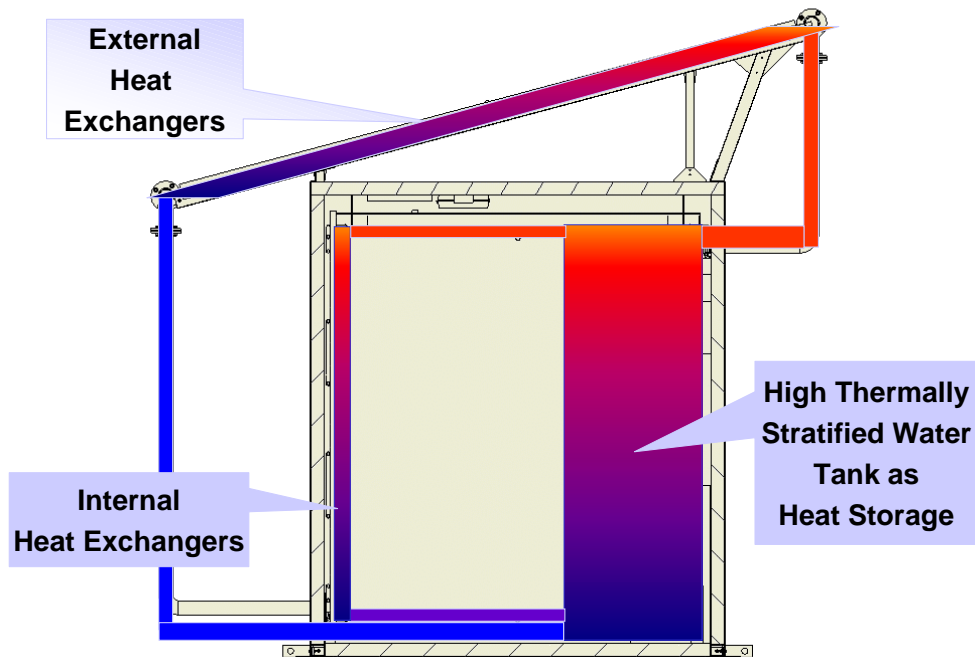

Passive Cooling System: Day

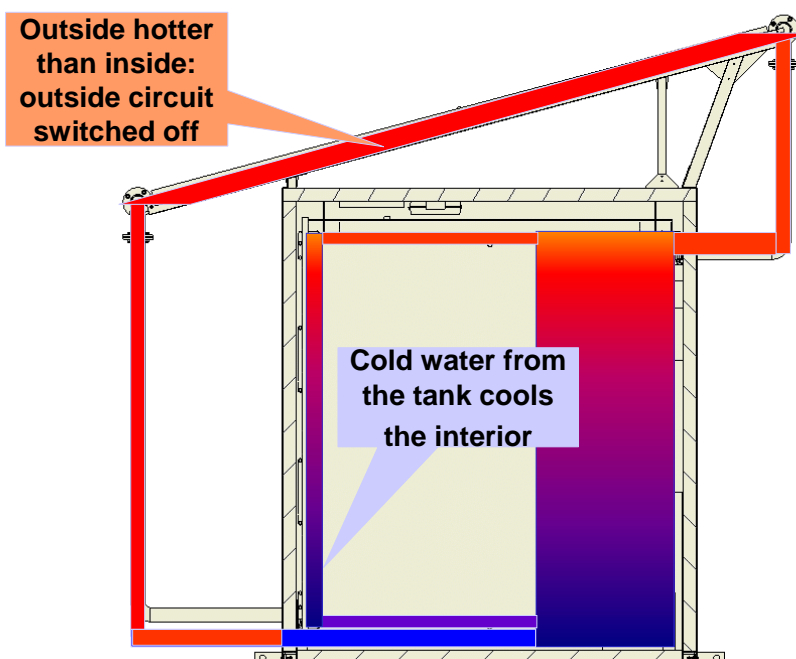



Passive Cooling System: Night

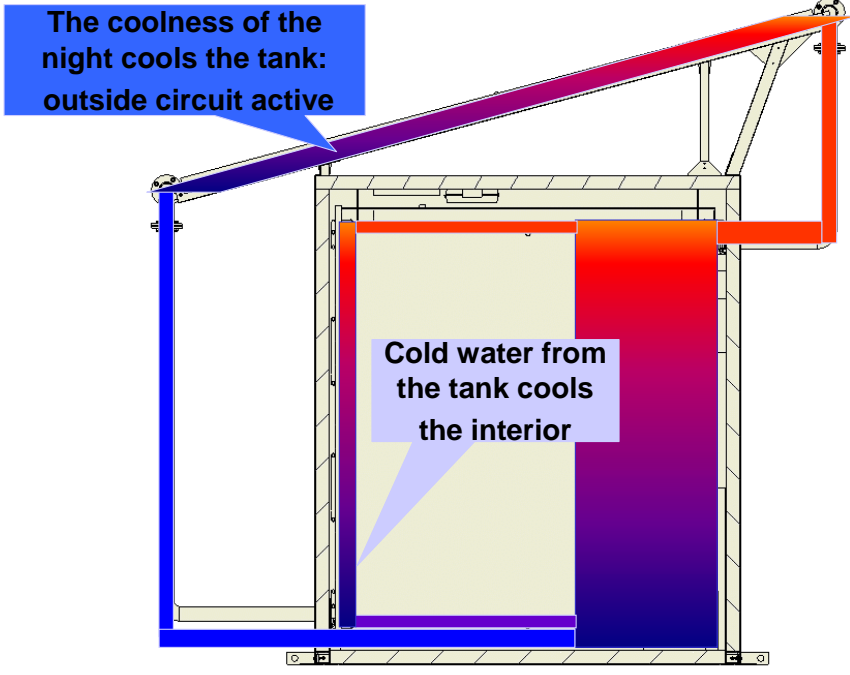

The 'temperature peaks' are leveled off. Theoretically the cooled interior temperature to maintain is limited to the ambient temperature of the night before.

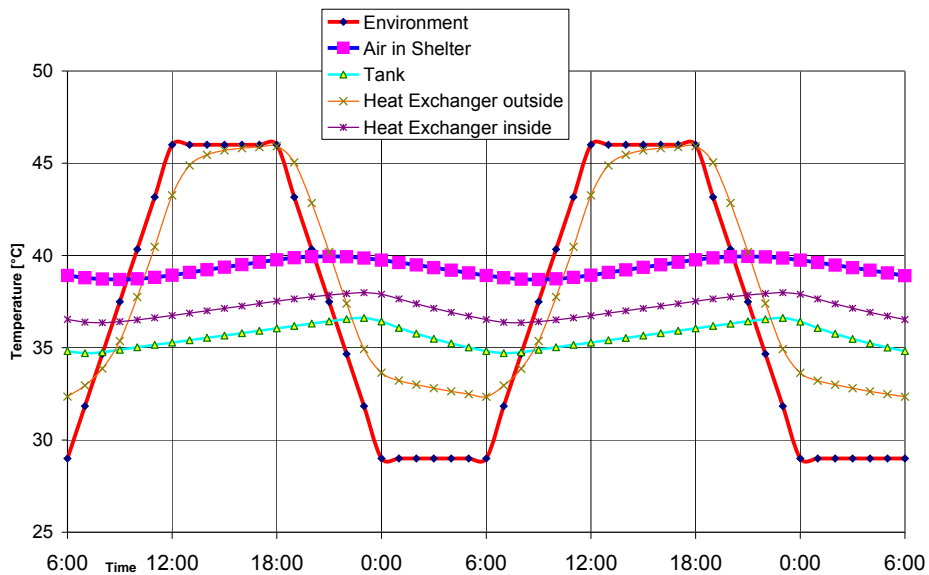



3 Lay Out of the Passive Cooling System with the dynamic simulation tool 'INTERSIM'

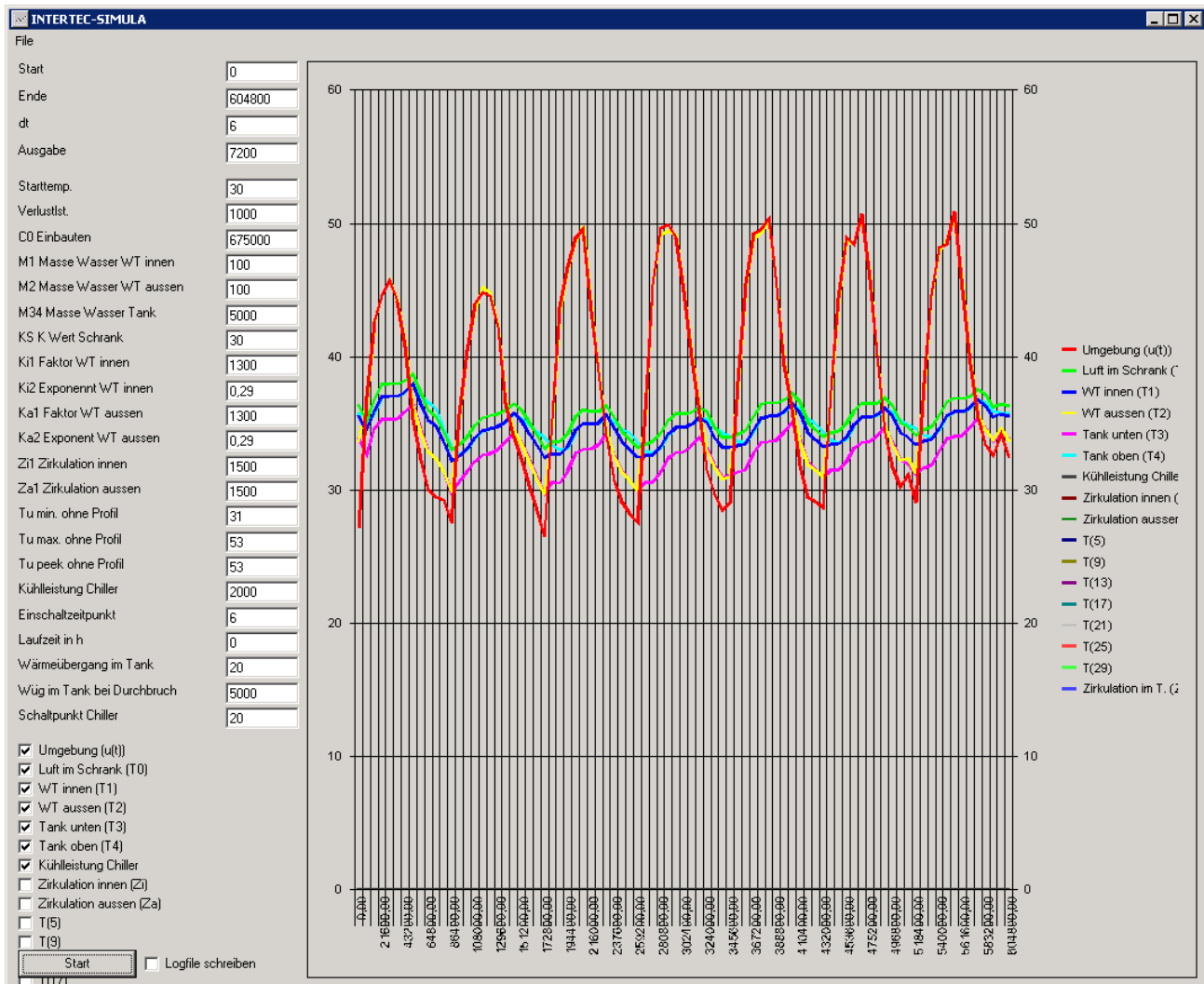

INTERSIM is based on an electrical comparison model of a resistance network with resistances and capacities. The passive cooling system can be simulated and laid out exactly.

INTERTEC has designed, built and performance tested a number of passive cooled shelters. At every project, the theoretical values could be adjusted to the measured values. Therefore the simulation is quite exact meanwhile.

The simulation can be based on a simplified outside temperature gradient or, if known in the real, measured temperature trend.



4 Selection of the Right Type of Passive Cooler

The most important parameters to lay out a passive cooler are:

- the heat dissipation of the equipment in the housing (average over 24 h)
- the night outside air temperature of the night before the hottest day.
- The max. allowed temperature inside the shelter.

The difference between the mentioned temperatures (delta T) is the driving force to transport the heat out of the housing.

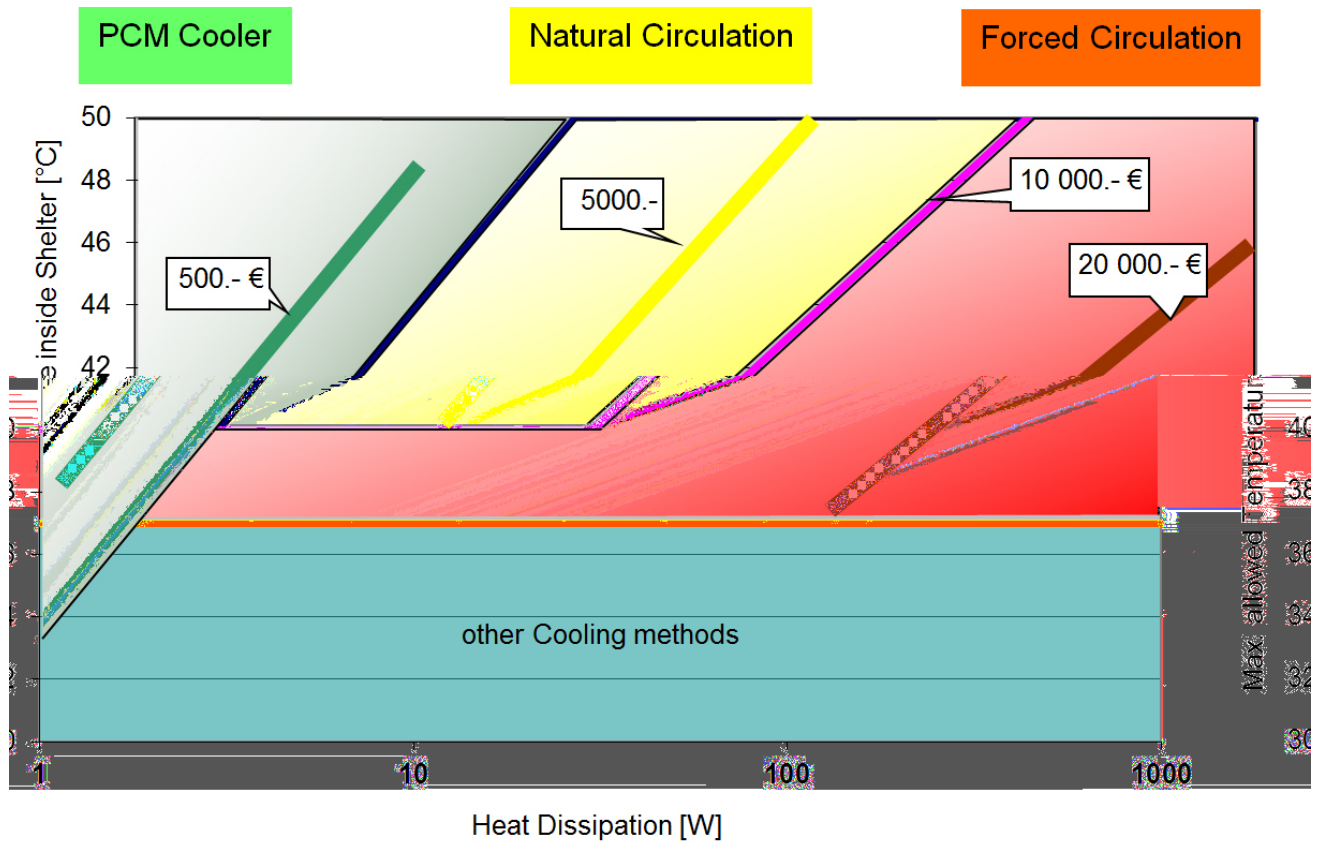

The € numbers mean the approx. cost for the passive cooling system (without housing etc.)



4.1 FC-PCS : Forced Circulation Passive Cooled Shelters



SCADA Shelter for a drinking water pipeline in the UAE/Fujairha

The liquid circulation of this type of passive cooled shelters is operated by 12V DC pumps. The electrical energy consumption averages at only 10 W. totally. The required energy, if not available, can be provided by solar panels.

This concept as a rule of thumb doubles the performance of the PCS

Why? The performance of a passive cooler is limited by the sum of the temperature differences (delta T) . The minimum practical delta T for a natural convection cycle is 3 K.

A forced convection by small pumps needs practically no delta T , that saves $2 \times 3 \text{ K} = 6 \text{ K}$, the internal temperature can be 6 K lower at the same size of heat exchangers and tank.

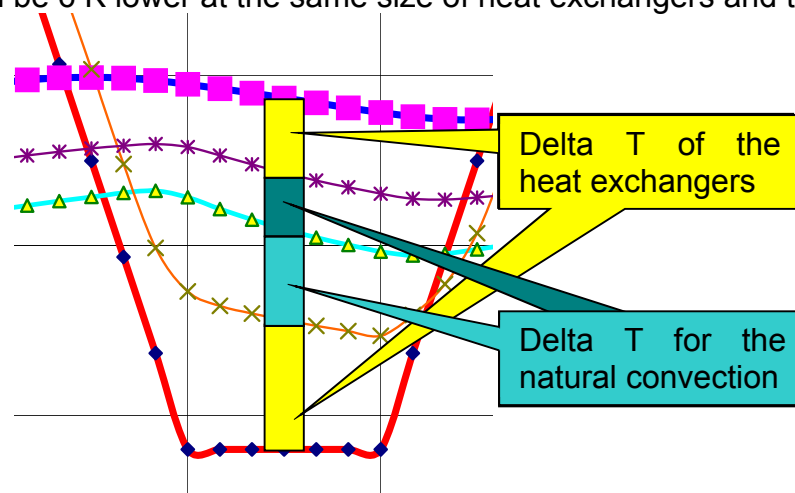



Advantages of FC-PCS : Forced Circulation Passive Cooled Shelters

- heat exchanger position can be designed to practical needs, i.e. at walls
=> Outside heat exchangers are easy accessible for cleaning after a sand storm.
- Minimized over all dimensions: Makes it possible to ship the passive cooled shelter in one piece using the ISO container dimensions = moderate shipping cost.
- Enables Direct cooling of electronic components by conduction
- Thermal conduction is a much (approx. 10 times) more effective heat transfer mechanism than the convection of air. Heat exchanger, can be mounted directly to the objects that need to be cooled or heated.



Redundant, very reliable brush less, magnetic coupled pumps

4.2 PCS : Natural Circulation Passive Cooled Shelter

Without any energy supply

4.2.1 SCADA Shelters for 64 well head stations of the ADCO SAS project

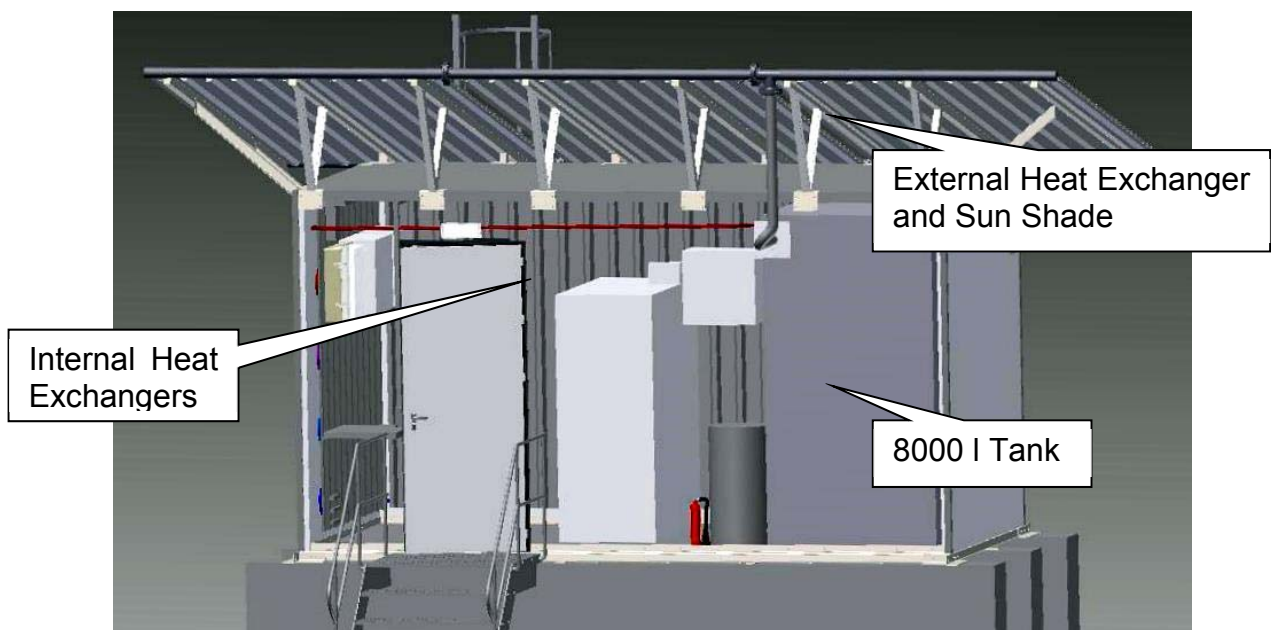



4.2.2 SCADA Shelter of an oil pipeline in the Sudan/Muglad



A 'classical' passive cooling with liquid cycle by natural convection.
With 500 W, very massive pipes are necessary to minimize the flow resistance.
The top part with the outside heat exchangers was transported separately and installed on site.



4.2.3 Analyzer station in a power plant in the Middle East



A Classic cabinet with a passive cooling system that does not need any energy. The utilizable volume amounts to approx. 150x100x50cm (HxBxD). Depending on climate conditions an inside temperature can be held by 40°C with an energy dissipation from 30 W to 100 W.

The Passive Cooler concept is a simple and competitive alternative for very expensive Ex-proof airconditioning units.



4.3 Passive Cooling solutions without heat exchangers

4.3.1 PCM passive cooler

Designed for installation of small devices (transmitters or electronic modules) with heat dissipation of 10 W or less to maintain the temperature of the electronics 10 K below the peak ambient temperature.

Advantages

- No energy or power supply required
- Cost effective
- Maintenance free
- IP65 up to IP68 , no fan or louvers to reduce the IP rating
- Very rugged design
- Solid state, no moving parts

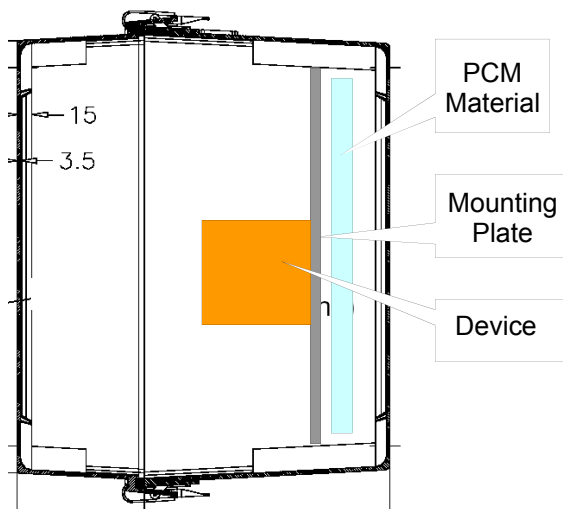

All components are designed for optimal performance:

- 'Arctic PP' enclosures with excellent insulation properties and no heat sinks
- PCM (phase change material), a material that 'melts' and 'freezes' at 93 F/ 34°C and stores the resulting energy at this level
- Optimal installation: no heat sinks to ambient conditions,
- good heat transfer between instrument and PCM due to heat conduction.
- Sun shade, not only on top of the enclosure, but along sides, if necessary



4.3.2 passive cooled enclosure for the satellite SCADA system of a gas distribution network

In this case for a satellite SCADA system of a gas distribution network the electronics had to be protected against temperature peaks of only few hours.

Due to the precisely defined thermal insulation of the enclosure and the sun shade, the thermal capacity of the lead-acid battery is enough, to limit the temperature of the SCADA controller to 60°C at a heat dissipation of 5 W .

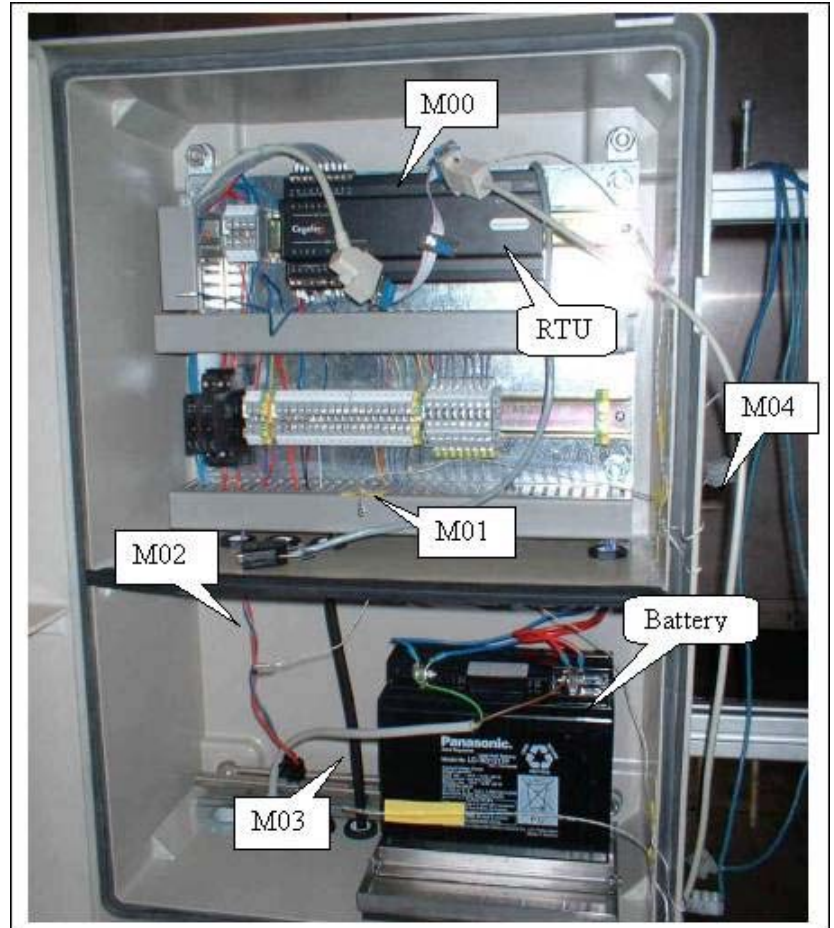

Testing in a climate chamber



5 Guide Lines for Optimal Specification

5.1 To optimize the temperatures and power means to minimize the cost

The temperature differences (delta Ts) in a Passive Cooling System are much smaller than in an active air conditioner. That means that every °C, Kelvin or Fahrenheit is very valuable. Example: In a typical application +50 °C day / +30°C night the size of heat exchangers and tank to maintain 40°C inside is more than double the size to maintain 45°C.

At the other hand it is important to specify the right Wattage of the heat loss of the electrical equipment. Every Watt of heat energy has to be stored during the day and transported to the outside during the night. Please see also the INTERTEC document "Every C counts.pdf"

5.2 Size

Passive cooled shelters should not be oversized. Good thermal insulation is mandatory because the passive cooling system gets very big and expensive when the necessary cooling power is high. Every m² of outside surface causes additional heat ingress.

5.3 Thermal Insulation

Very good thermal insulation is the base of the function of a passive cooled shelter. The whole structure has to be designed avoiding thermal short-cuts. At the usual shelter design heat sinks like steel beams, door frames and cable ducts cause a huge loss of cooling energy.

5.4 Transportation

To design the shelter layout to a maximum width of 2.28 m (which is the ISO sea container's inside width) can save a lot of transportation and packing cost.

It makes sense to 'pack' the completely installed shelter inside an 'open top ISO container. So it can be transported from the place of manufacturing to the final destination at moderate cost without the danger of being damaged.

'Seaworthy packing' is not necessary because the GRP shelter itself has a high degree of ingress protection and is corrosion resistant.

5.5 Sun Shade

To avoid a high additional heat power by sun radiation it is absolutely necessary to place the shelter in the shade. INTERTEC usually ships shelters with an integrated sun shade. It is removable and stored inside shelter during transportation.

Ladder for roof access not necessary and useless unless equipment like the solar panels are installed on the roof. Solar panels can be used as sun shade. It is important that the panels are easily accessible to remove the dust after a sand storm.

5.6 Explosion proof requirements

Ex – Zone: if necessary, the passive cooled shelter has to meet the requirements of IEC 60079-0 ff. (Antistatic, installations etc.)

Battery room: if the batteries produce hydrogen during charging, the battery room might be Ex-Zone 2 or 1.



6 Alternative Solutions for Outdoor Thermal Management

Please contact the INTERTEC engineering department to select the optimal solution for you application.

6.1 The Use of Colder Media

If cooling water is available, which must be only colder 2-3°K than the required interior temperature, there might not be a need for a water tank. The heat exchanger can be designed accordingly, which simplifies the Passive Cooler.



Water Cooled Gas Chromatograph for a Gas Plant in the Gulf area

Other Options:

- **filter fan**
- **air-to-air heat exchangers**
- **instrument air**
- **Vortex - cooler**
- **Peltier - cooler**
- **Electrical heating for condensation protection**

The silver bullet solution:

- **Avoid cooling by intelligent combination of well insulated enclosure and equipment condensation protection**

6.2 Hybrid : Combination of Active and Passive Cooler

In this case the active cooler can be laid out 'small' without reserves and redundancy. The passive cooler (e.g. PCM passive cooler) acts as a

- **Booster for the hottest hours of the hottest days**
- **back-up for some hours until the active cooler is repaired**



6.3 ATEX- Air Conditioning Unit

The air conditioning unit has been designed for installation on the external wall of the protective cabinet or shelter. It is suitable for application in the open at ambient temperatures ranging from $-35\text{ }^{\circ}\text{C}$ to $+55\text{ }^{\circ}\text{C}$.

Ex-approval allows for application up to zone 1.

The components of the air conditioning unit are accommodated in a corrosion-proof housing made of the same material as the INTERTEC protective cabinets.

For custom applications, INTERTEC can supply complete units consisting of an air conditioning unit and a protective cabinet or

shelter.

Protective cabinets can also be supplied in Ex p design.



Explosion Protection

ATEX Examination Certificate	TÜV 06 ATEX 2958
ATEX Type of protection (Gas)	II 2G Ex px mb e IIC T3 (Suitable for Zone 1)
CSA Certificate	CSA File # 1913298
CSA Type of Protection	Class 1, Div. 2, Class 1, Zone 1, Groups A, B, C and D

6.4 ATEX Ex p Purged and Active Cooled Video Surveillance System for a Refinery in Algeria

Cold air from an very well insulated INTERTEC GRP shelter for the concentrator with INTERTEC ATEX air conditioner is conducted to very well insulated INTERTEC GRP sandwich camera boxes by hoses. This solves several problems:

- ATEX Zone 1 certified (equipment inside non Ex)
- Equipment kept cool (ambient temperature up to $100\text{ }^{\circ}\text{C}$)
- Environmental protection (sand , corrosion)
- Theft and vandalism protection





6.5 ATEX Water Chiller and Analyzer Cabinet

For Saudi Aramco Haradh Al Crude Increment III Gas and Oil Separator Plant in Saudi Arabia.

A closed loop water/glycol circulation cools the sample and the cabinet of an oil in water analyzer.



6.6 Water Cooled Cabinet for Yokogawa GC in Syria

Cabinet and process air for the Gas Chromatograph is cooled with cooling water.

An explosion proof control system with thermostats and solenoid valves controls the temperature.



Air Cooler





7 Advantages of INTERTEC Passive Cooling Systems

- ❑ No or very small (< 10 W) auxiliary energy needs.
- ❑ high reliability, no or almost no moving parts
- ❑ closed loop system=>no evaporation=>no maintenance
- ❑ Custom designs according for the application and needs.

Options

- High wind loads
- Explosion proof
- Fire rating (i.e. F30)
- Earth quake proof
- Many more

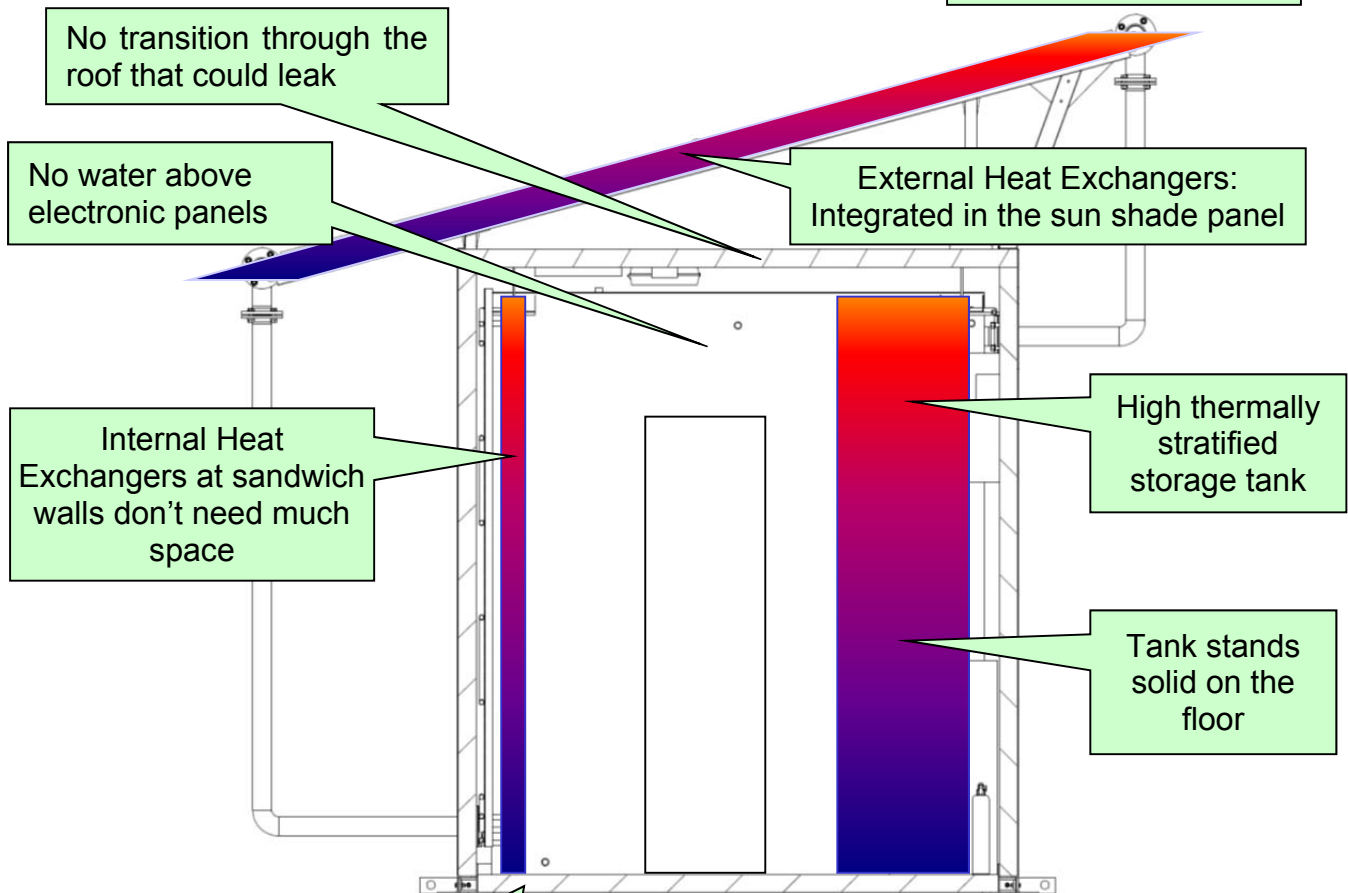

GRP sandwich Shelter

- High IP rating (e.g. IP65)
- Insulation ensures good K-value and limits required cooling.
- Optimized design avoids thermal short-cuts and heat sinks
- Flexible and modular system
- Chemical and corrosion resistant
- No maintenance cost
- Light weights (transport), high stability

Complete integration and configuration from one hand

INTERTEC can offer in house:

- Engineering, Lay out
- Production, Assembly
- Testing and
- Documentation

Of

- Shelter
- Passive Cooling System
- electrical (power distribution, lighting) and mechanical installations